

AIR CONDITIONING

Slim Duct - Standard Series (Horizontal Only)

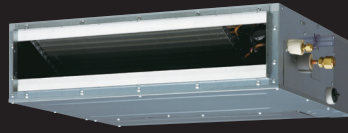

ARXG09KLLAP / AOYG09KBTB
 ARXG12KLLAP / AOYG12KBTB
 ARXG14KLLAP / AOYG14KBTB
 ARXG18KLLAP / AOYG18KBTB



ARXG09/12/14KLLAP

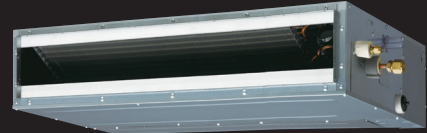

ARXG18KLLAP



High efficiency and slim design

The slim design allows installations where ceilings are narrow. Drain hose as standard accessory*



SEER
6.20
 (09/18 models)

SCOP
4.30
 (09 model)



Height
198 mm
 Drain pump built-in



*R32 Model cannot be installed vertically



Selectable with a wide range of static pressure

By using the DC fan motor, it is possible to change the static pressure range from 0 to 90 Pa. The change of static pressure range is possible by remote controller.



Static pressure range
 0 to 90 Pa



Low ambient operation

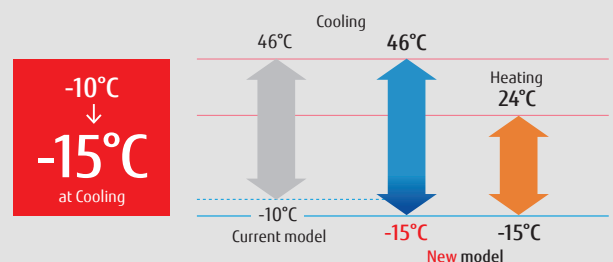

Compact and lightweight outdoor unit

Compact and lightweight outdoor unit expands a wider range of choice for installation location. This makes it easier to use this outdoor unit.



**Model: ARXG09KLLAP / ARXG12KLLAP / ARXG14KLLAP / ARXG18KLLAP
AOYG09KBTB / AOYG12KBTB / AOYG14KBTB / AOYG18KBTB**

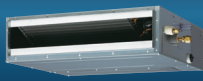

ARXG09/12/14KLLAP

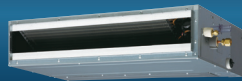

ARXG18KLLAP



AOYG09/12/14KBTB



AOYG18KBTB

Optional parts

Wired Remote Controller: UTY-RNRYZ3, UTY-RVNYM,
Simple Remote Controller: UTY-RSRY, UTY-RSNYM

IR Receiver Kit: UTY-LBTYM
Wireless LAN Interface: UTY-TFSXZ1
Remote Sensor Unit: UTY-XSZX

Auto Louver Grille Kit: UTD-GXTA-W (ARXG12/14KLLAP),
UTD-GXTB-W (ARXG18KLLAP)
External Connect Kit: UTY-XWZXZG

Dimensions

Indoor unit :
ARXG09/12/14/18KLLAP

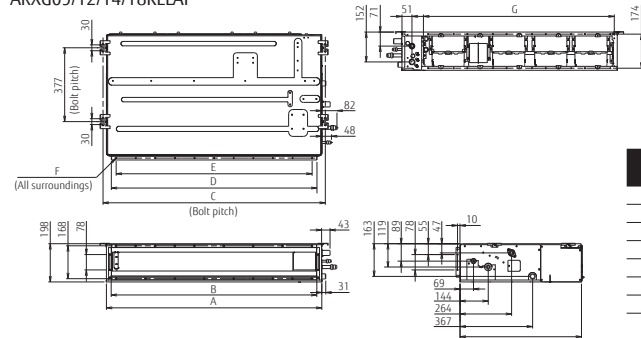

	ARXG09/12/14 KLLAP	ARXG18 KLLAP
A	700	900
B	650	850
C	734	934
D	650	850
E	P100x6-600	P100x8-800
F	18xØ5	22xØ5
G	574	774

Outdoor unit : (Unit : mm)
AOYG09/12/14KBTB

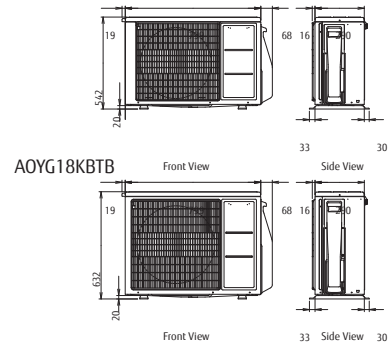

Specifications

Model No.	Indoor unit		ARXG09KLLAP	ARXG12KLLAP	ARXG14KLLAP	ARXG18KLLAP
	Outdoor unit		AOYG09KBTB	AOYG12KBTB	AOYG14KBTB	AOYG18KBTB
Power Source	Single-phase, ~230V, 50Hz					
Capacity	Cooling	kW	2.5 (0.9-3.2)	3.5 (0.9-4.4)	4.3 (0.9-5.4)	5.2 (0.9-5.9)
	Heating		3.2 (0.9-4.7)	4.1 (0.9-5.7)	5.0 (0.9-6.5)	6.0 (0.9-7.5)
UK Total/sensible cooling			2.37/1.86	3.39/2.54	4.12/3.13	5.01/3.69
Input Power	Cooling/Heating	kW	0.60/0.79	0.93/1.08	1.28/1.32	1.55/1.62
EER	Cooling	W/W	4.17	3.76	3.36	3.35
COP	Heating		4.05	3.80	3.79	3.70
Pdesign	Cooling/Heating(-10°C)	kW	2.5/2.6	3.5/3.4	4.3/3.8	5.2/4.4
SEER	Cooling	W/W	6.20	6.10	5.80	6.20
SCOP	Heating		4.30	4.00	3.90	4.10
Energy Efficiency Class	Cooling	A++		A++	A+	A++
	Heating	A+		A+	A	A+
Annual Energy Consumption	Cooling	kWh/a	141	201	259	293
	Heating		845	1,189	1,362	1,501
Moisture Removal			0.7	1.3	1.5	2.0
Sound Pressure Level	Indoor (Cooling)	H/M/L/Q	28/27/26/25	29/28/26/25	32/30/28/26	32/30/29/27
	Indoor (Heating)	H/M/L/Q	28/26/25/24	29/28/26/24	32/30/28/25	32/30/29/27
Sound Power Level	Outdoor(Cooling/Heating)	High	46/46	47/47	49/49	50/50
	Indoor(Cooling/Heating)	High	57/57	58/58	60/60	58/58
Airflow Rate	Outdoor(Cooling/Heating)	High	59/59	61/61	62/62	62/62
	Indoor / Outdoor (Cooling)	High	600/1,480	650/1,580	800/1,670	940/2,160
	Indoor / Outdoor (Heating)	High	600/1,410	650/1,520	800/1,580	940/1,830
Static pressure range (Standard)			0 to 90 (25)	0 to 90 (25)	0 to 90 (25)	0 to 90 (25)
Net Dimensions H x W x D	Indoor	mm	198x700x620	198x700x620	198x700x620	198x900x620
	Outdoor	mm	542x799x290	542x799x290	542x799x290	632x799x290
Weight	Indoor	kg(lbs)	17 (37)	17 (37)	17 (37)	20 (44)
	Outdoor	kg(lbs)	32 (71)	33 (73)	33 (73)	36 (79)
Remote Controller Type (NOT Supplied With Unit)	NO CONTROLLER SUPPLIED WITH THESE UNITS PLEASE ORDER SEPARATELY					
Interconnecting Cable (Suggested cable size 1.5mm)	3 Core + Earth					
Suggested MCB Size	Amp		10	10	16	16
Max. Operating Current	Cooling/Heating	A	7.9	9.7	10.2	12.1
Power Supply To	Outdoor					
Connection Pipe Diameter (Gas / Liquid)	Inch		3/8 & 1/4	3/8 & 1/4	3/8 & 1/4	1/2 & 1/4
Max Pipe Length (Pre-Charge)	m		20 (15)	25 (15)	25 (15)	30 (20)
Max Height Difference			15	20	20	20
Operation Range	Cooling	°CDB	-15 to 46	-15 to 46	-15 to 46	-15 to 46
	Heating		-15 to 24	-15 to 24	-15 to 24	-15 to 24
Refrigerant	Type	R32		R32	R32	R32
	Charge	g	850	850	850	1020
	Additional Charge	g/m	20	20	20	20

*Specifications and design are subject to change without notice for further improvement.
*Actual products' colours may be different from the colours shown in this printed material.

Distributed by :



ISO 9001
Certified number: 01 100 075229
Fujitsu General (Thailand) Co., Ltd.



ISO 9001
Certified number: 1591702007385M
Fujitsu General Central Air-conditioner(Wuxi) Co., Ltd.

FUJITSU GENERAL AIR CONDITIONING (UK) LTD
Unit 150 Centennial Park, Centennial Avenue, Elstree, Herts. WD6 3SG
www.fujitsu-general.com/uk
Tel: +44 (0)208 731 3450 Fax: +44 (0)208 731 3451

Copyright© 2018 Fujitsu General Limited. All rights reserved. 3EFNP31-1812E